

**ASSAB TOOL STEEL FOR**  
**FORGING**  
**APPLICATIONS**



# HOT FORGING OF METALS

In hot forging a heated up billet is pressed between a die set to a nearly finished product. Large numbers of solid metal parts are produced in aluminium alloys, copper alloys, steel or super-alloys where irregular shapes need to be combined with good mechanical properties. The main methods of drop forging are hammer forging and press forging.

## HAMMER FORGING

Hammer forging is characterised by a very short contact time and very rapid rate of increase of force with time (impact loading). The cumulative contact time for the bottom die can be fairly long if one includes the time between blows. However, since a lubricant with “blow-out” effect is normally used with hammers, effective contact between the part and the die only occurs during the actual forging blow.

These features imply that impact toughness and ductility are important properties for die steel to be used in hammer dies. This does not mean to say that wear resistance is not important, particularly in smaller dies, which in fact normally fail as a result of wear. In hammer forging, there is a lot to be said for using inserts of a more wear-resistant die steel which are shrink fitted into a tough holder material.



## CONTENTS

HOT FORGING	2
WARM FORGING	5
PROGRESSIVE FORGING	6
EFFECT OF FORGING PARAMETERS ON DIE LIFE	8
DIE DESIGN AND DIE LIFE	9
REQUIREMENTS OF DIE MATERIAL	10
MANUFACTURE AND MAINTENANCE OF FORGING DIE	12
SURFACE TREATMENT	13
PRODUCT PROGRAMME FOR FORGING APPLICATION	14
TOOL STEEL SELECTION CHART	15

“ASSAB” and the logo are trademark registered. The information contained herein is based on our present state of knowledge and is intended to provide general notes on our products and their uses. Therefore, it should not be construed as a warranty of specific properties of the products described or a warranty for fitness for a particular purpose. Each user of ASSAB products is responsible for making its own determination as to the suitability of ASSAB products and services.

Edition 20210505

For larger, high-production hammer dies, which may be resunk a number of times, it is important that the die steel used has sufficient hardenability that the later cavities are not sunk in softer material with inferior wear resistance.

## PRESS FORGING

In press forging, the contact time under pressure is much longer, and the impact load is much lower than in hammer forging. In general terms, this means that the heat resistance and elevated temperature wear resistance of the die steel are relatively more important than the ability to withstand impact loading. However, one must optimize impact toughness and ductility in relation to wear resistance; this applies particularly for large press dies which are not supported from the sides. Since the surface temperature of press dies will during service generally be higher than for hammer dies, it is important that the die surface is not excessively chilled by lubrication. Otherwise, premature heat checking or even thermal shock cracking may result.

## TYPICAL DIE FAILURES

The deterioration of forging dies is usually associated with several processes which may operate simultaneously. However, one of these normally dominates and is the ultimate cause of failure. In general, four distinct damage mechanisms can be distinguished:

- wear
- mechanical fatigue and gross cracking
- plastic deformation
- thermal fatigue cracking (heat checking)

Different damage mechanisms can dominate in different parts of the cavity.

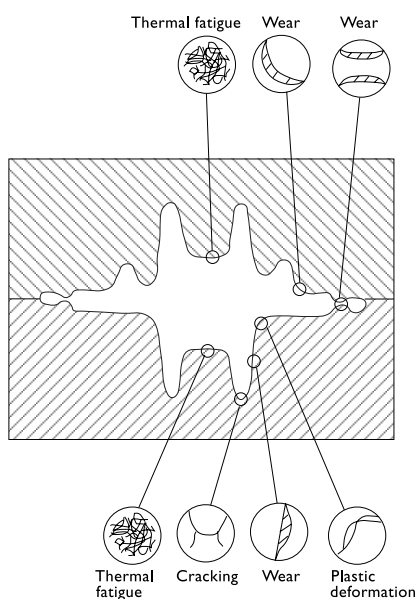

## WEAR

If all other failure mechanisms are suppressed, a forging die will ultimately wear out (parts out of tolerance). Wear occurs when the work material plus oxide scale glide at high velocity relative to the cavity surface under the action of high pressure. It is most pronounced at convex radii and in the flash land. Wear is increased drastically if the forging temperature is reduced (higher flow stress for the work material).

The explosion which occurs via combustion of oil-based lubricant in the confined space between forging and die can also give rise to a type of erosive wear.



Wear

## GROSS CRACKING

Forging dies might fail as a result of some form of gross cracking. This may occur during a single cycle or, as is most common, over a number of cycles; in the latter instance, the crack growth proceeds via a high-stress fatigue mechanism. Gross cracking is more frequent in hammer blocks than in press tooling, because of the greater degree of impact.



Gross cracking is a failure condition which can almost always be rectified. Normally, cracking lies in one or more of the following:

- overloading, e.g. work material temperature too low
- die design, e.g. too sharp radii or too thin wall thickness
- inadequate preheating of the die
- inadequate toughness of die steel (wrong selection)
- too high hardness of die material
- poor quality heat treatment/surface treatment
- inadequate die support/alignment

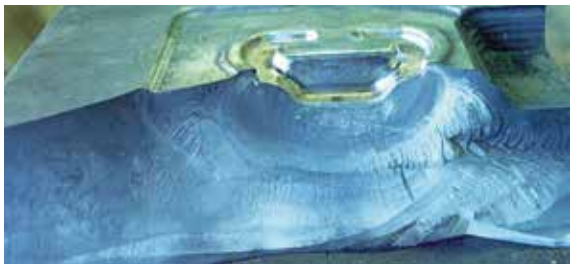

Totally cracked die

### PLASTIC DEFORMATION

This occurs when the die is locally subjected to stresses in excess of the yield strength of the die steel. Plastic deformation is quite common at small convex radii, or when long thin tooling components e.g. punches, are subjected to high bending stresses.

The following can be the cause of plastic deformation in forging dies:

- too low billet temperature (high flow stress of work material)
- inadequate hot strength of die steel
- die temperature too high
- die material too soft

### THERMAL FATIGUE CRACKING

This results if the surface of the cavities is subjected to excessive temperature changes during the forging cycle. Such temperature changes create thermal stresses and strains at the die surface which eventually lead to cracking via a low-cycle fatigue mechanism (heat checking).

Thermal fatigue cracking is increased by the following factors:

- cavity surface at too high temperature (excessive billet temperature and/or long contact time)
- excessive cooling of die surface between forgings
- inadequate preheating of die
- wrong selection of die steel and/or poor heat treatment

All these factors will increase the difference between maximum and minimum temperature in the die surface.



## DIE MATERIAL PROPERTIES

The properties profile required for tool steel in forging dies depends to some extent on the type of forging operation, on the work material and on the size of the part, depth of cavity etc.

However, a number of general characteristics will always be required in all forging operations. The particular die damage mechanisms are given in parentheses.

- Sufficient hardness and ability to retain this at elevated temperatures—temper resistance (wear, plastic deformation, thermal fatigue cracking).
- Enhanced level of hot tensile strength and hot hardness (wear, plastic deformation, thermal fatigue cracking).
- Good toughness and ductility at low and elevated temperatures (gross cracking, thermal shock cracking, thermal fatigue cracking). It is important that the die steel exhibits adequate toughness/ductility in all directions.
- Adequate level of fatigue resistance (gross cracking).
- Sufficient hardenability (retention of wear resistance etc. if the die is resunk).
- Amenability to weld repair.
- Good machinability, especially prehardened die blocks.

## WARM FORGING

Warm forging is a precision forging operation carried out at a temperature range between 550–950°C. It is useful for forging of details with intricate shapes, with desirable grain flow, good surface finish and tighter dimensional tolerances than if hot forged.

The weight of the forged piece is between 0.1–50 kg and the production rate about 10–40 pieces per minute. The contact time is about 200 ms and the mechanical loads at 600°C are 3 to 5 times higher than in hot forging.

Automatic multistation presses with integrated cooling/lubricating systems are often used.

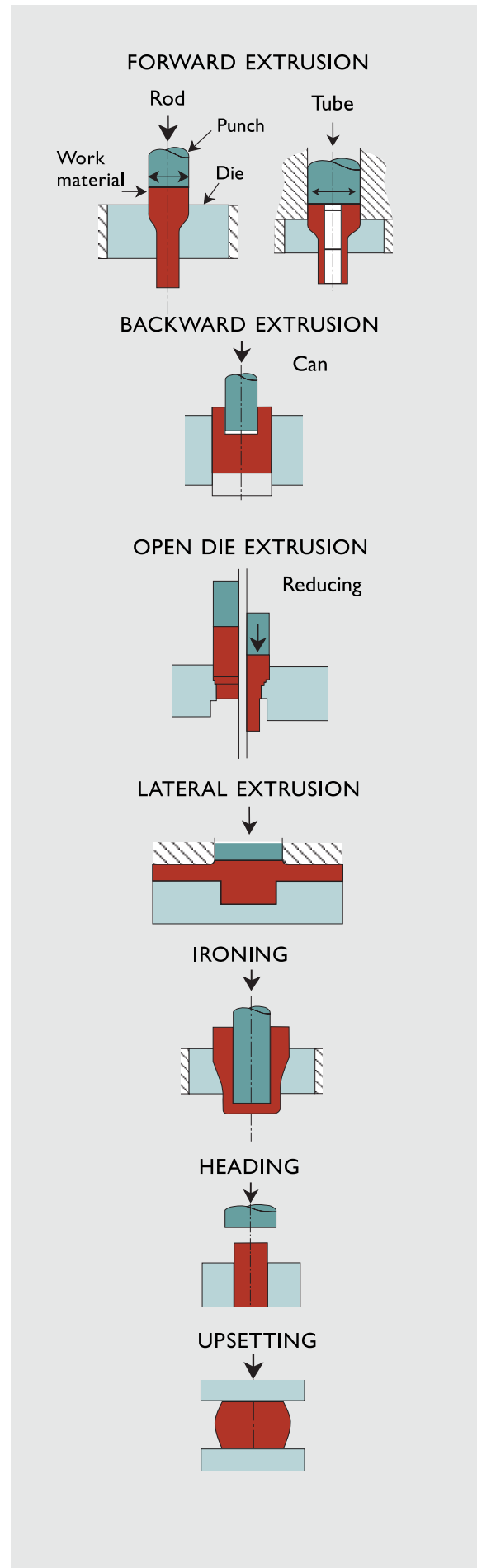

Typical processes in warm forging

## TYPICAL FAILURES

During the warm forging operation the tool parts are exposed to rather high temperature, high mechanical loads and intensive cooling.

As a result of this alternate heating and cooling the tool parts are subjected to high thermal fatigue.

An additional factor is the degree of hot wear of the material, which depends on the surface temperatures and the mechanical stresses on the tool.

## TOOL MATERIAL PROPERTIES

The tool parts are subjected to both high mechanical stresses and high thermal stresses.

For these reasons a tool steel has to be chosen which has a good temper resistance, good wear resistance, high hot yield strength, good thermal conductivity and good thermal fatigue resistance. A warm forging steel must exhibit a properties profile which is in between the typical properties profiles for hot work and cold work steel.

## PROGRESSIVE FORGING

In progressive forging a large number of symmetrical, precision-forged parts with forged weights of up to about 5 kg are produced.

The fully automatic process involves supplying hot rolled bars at one end of the line, heating them inductively, cutting them to the required size, shaping them in 3–4 stages and discharging finished forgings at the other end of the line.

Depending on the weight of the forgings, production capacity is between 50 and 180 per minute.

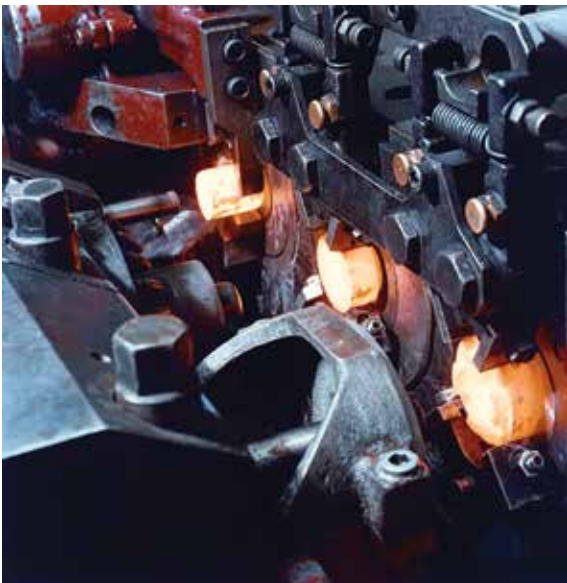

## TYPICAL FAILURES

Tool parts used in the progressive forging, such as die, stem, stem holder, punch and counter punch-ejector are subjected to very high stresses.

As the production speed is very high, the die parts need to be water-cooled to protect them against overheating. Nevertheless, despite intensive cooling, the tool surfaces can be strongly heated, even by the brief contact, with the hot metal being forged.

As a result of this alternate heating and cooling the die parts are subjected to extremely high thermal fatigue. The degree of the thermal fatigue cracking constitutes a measure of the material life.

An additional factor is the degree of hot wear of the material, which depends on the surface temperatures and the mechanical stresses on the die.

## TOOL MATERIAL PROPERTIES

The required properties profile of the hot forming die and die parts are:

- high temperature strength and good temper resistance to withstand hot wear and thermal fatigue cracking
- good thermal conductivity to withstand thermal fatigue cracking
- good hot ductility and toughness to resist initiation and rapid spread of thermal fatigue cracking

## FORGING IN A FULLY AUTOMATIC PROCESS

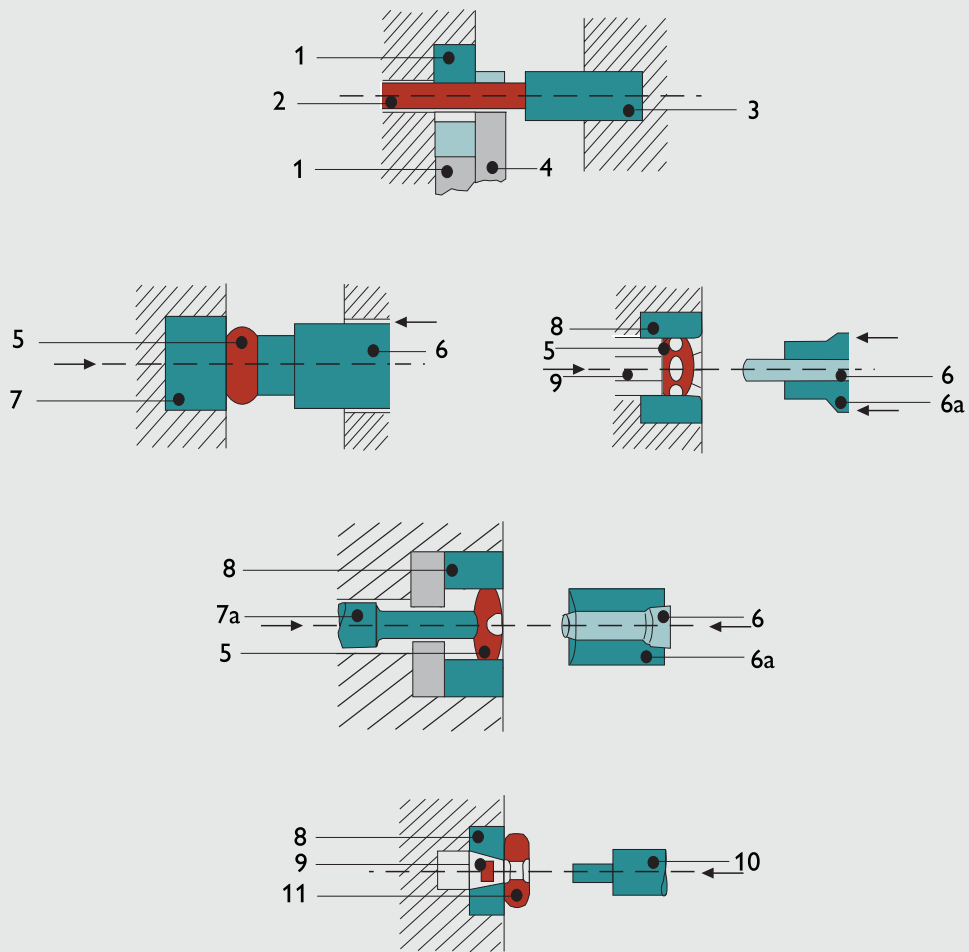

1. Two-part cutting bush
2. Work metal
3. Stopper
4. Cutter
5. Blank
6. Stem/Punch
- 6a. Hollow punch
7. Bolster
- 7a. Counter punch-ejector
8. Die
9. Waste metal
10. Piercer
11. Product

# EFFECT OF FORGING PARAMETERS ON DIE LIFE

Apart from the influence of the actual die material and its heat treatment/surface treatment, a number of parameters related to the forging operation affect die life:

- billet temperature
- billet shape and surface condition
- work material
- cavity stress level and contact time
- type of forging operation
- type of lubricant

## BILLET TEMPERATURE

Reduced billet temperature in forging is favourable from the viewpoint of mechanical properties in the forged part itself. This is particularly important if the components are not heat treated after forging. However, the higher flow stress of the work material, which is associated with a reduced forging temperature, results in both increased wear and a higher risk for plastic deformation. Further, since the forging loads increase, the probability for gross cracking is enhanced.

## TYPICAL HOT FORGING TEMPERATURES

STEEL	1050 - 1250°C
CU-ALLOYS	650 - 800°C
AL-ALLOYS	350 - 500°C
TI-ALLOYS	800 - 1000°C

## BILLET SHAPE AND SURFACE CONDITION

The greater the difference between the shape of the billet and that of the final forging, the greater is the degree of wear because the relative movement between work material and die must increase. Likewise, hard, adherent scale on the billet surface will increase wear, especially if the gliding distance is large.

## WORK MATERIAL

The higher the flow stress of the work material, the faster is die deterioration due to wear and/or plastic deformation, at the same time as the risk for gross cracking is increased. Hence, stainless steel is more difficult to forge than carbon steel at the same temperature.

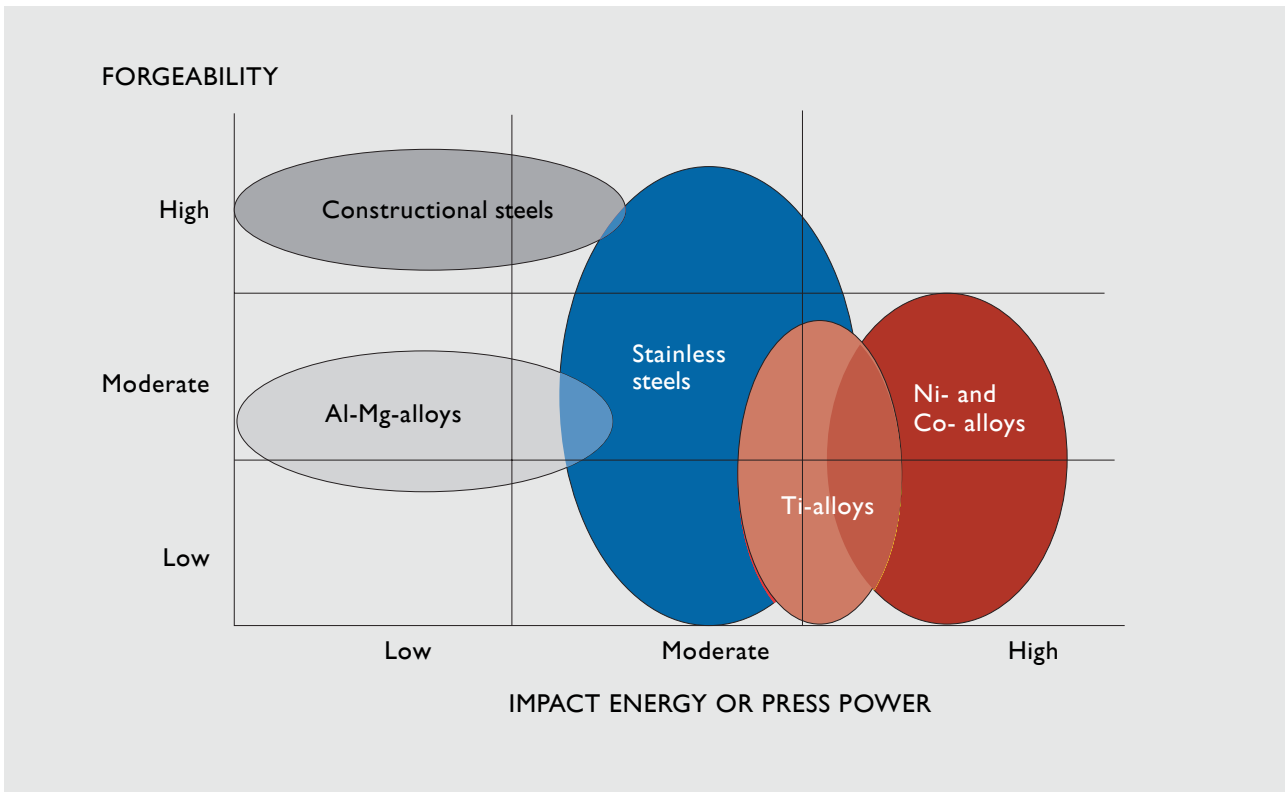

Forgeability of different types of material.



## CAVITY STRESS LEVEL AND CONTACT TIME

An increased stress level in the cavity, can be found, for example, in high precision forging, and has the following consequences:

- increased stress in the tool with higher risk for deformation or gross cracking
- increased heat transfer from billet to die (heat checking)
- more pronounced wear

Prolonged contact between billet and die during forging results in accelerated wear and a greater risk for heat checking. For very long contact times, the surface layer of the tool may become so hot that it transforms to austenite. Cracking problems can then be experienced if this layer rehardens during the cooling part of the cycle.

## TYPE OF FORGING OPERATION

Because of the much higher impact load, hammer dies tend to fail by cracking to an extent which is greater than in press forging where the loading rate is lower. Thermal fatigue (heat checking) is more common in powder forging and other near-net-shape forging processes involving long contact times.

## TYPE OF LUBRICANT

Oil-based lubricants can give rise to excessive wear/erosion due to the explosion-like combustion of the oil between billet and cavity. On the other hand, water base lubricants cool the die surface to a greater extent which increases the risk of thermal fatigue cracking.

## DIE DESIGN AND DIE LIFE

Assuming that the forging equipment is in good condition (properly adjusted and without excessive play in the ram guide system), then adherence to the following “die design” principles will reduce the risk for catastrophic die failure:

- proper die support
- dovetails, if used, should be properly dimensioned,
- have sufficiently large radii and be properly finished (grinding marks should be tangential and not axial), see figure below.
- sufficient wall thickness, and sufficient material below the cavity and between individual cavities
- adequate radii and fillets in the cavity
- proper dimensioning of flash land and gutter
- proper design of parting plane and, if used, die locks

- correct use and design of setting plugs, punches and knockout pins
- sufficiently large cushion-face area in hammer forging in relation both to die block thickness and to the capacity of the hammer used.

Improper die support, insufficient material thickness in the die and too small radii are all very common reasons for a die failing catastrophically by cracking, and will be further enlarged upon.

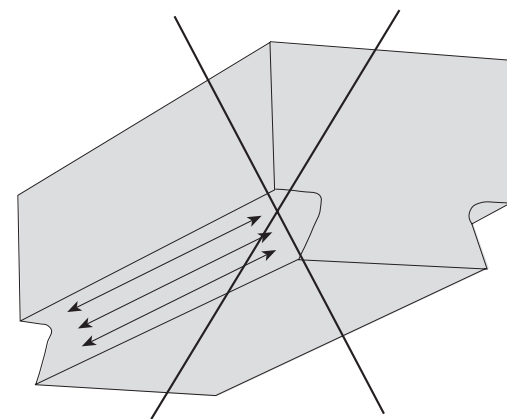
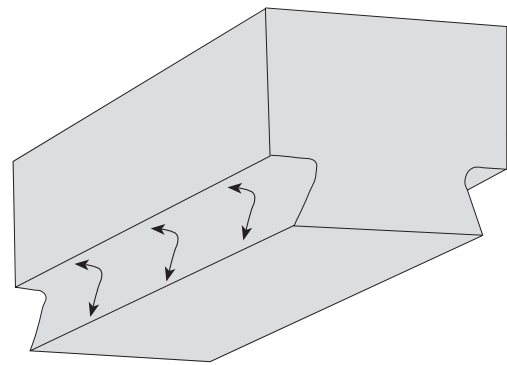

Grinding of dove-tail radii.

## DIE SUPPORT

It is very important that the die is properly supported underneath by a perfectly flat backing surface with sufficient hardness. Concave depressions in the support surface immediately under the die cavity are particularly deleterious because they exaggerate the tensile stresses at radii.

Proper backing is especially important in hammer forging because there is usually no side support in this case. When dies of greatly different dimensions are used on the same press or hammer, it is essential to remove any cavities in the backing block or plate when switching from a small to a large die.

For press forging, side support of the die is desirable but this is not always possible. Shrink fitting of inserts into a massive holder provides the best security against cracking in press dies.

## FILLET RADII

The greatest tensile stresses in a forging die occur at the radii between the sides and bottom of the cavity. The smaller the radius, the higher the stresses. In general, the forging should be designed so that die fillet radii less than 2 mm can be avoided. For deeper cavities, >50 mm, this radius limit needs to be increased to 5 mm (0.2 inch).

It is especially important during die making that radii are ground and polished with grinding marks, if any, in the tangential direction. In particular, EDM residues, which may contain cracks, must be removed completely at radii (and preferably from the rest of the die as well).

If this is not possible, then the die should at least be retempered at 25°C below the previous tempering temperature.

## DIE MATERIAL AND WALL THICKNESS

A number of more or less empirical methods or dimensioning of forging dies are available, which range in complexity from simple “rule of thumb” to fairly advanced nomograms with a theoretical base. However, there is no doubt that the stresses imparted to the die by a given forging machine increase profoundly as the die dimensions are decreased.

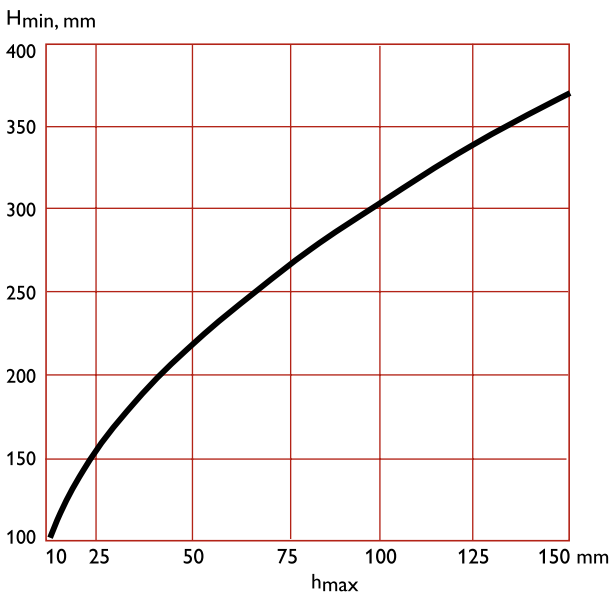

Minimum height (H<sub>min</sub>) of hammer dies with a maximum depth of cavity (h<sub>max</sub>).

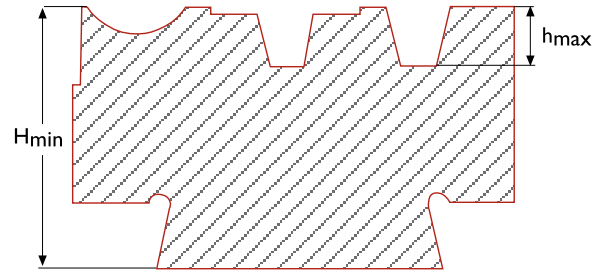

As a rule of thumb for solid die blocks in press forging the thickness below the cavity should be at least 1.5 x cavity depth.

As a minimum wall thickness in hammer forging the recommendations are according to the table below.

Depth of cavity (h) mm	Disatance cavity to outer edge of a die (t) mm
6	12
10	20
16	32
25	40
40	56
63	80
100	110
120	130
160	160

Mnimum wall thickness (t) recommended in hammer dies between cavity and outer edge.

## REQUIREMENTS FOR DIE MATERIAL

### HARDENABILITY

In large press or hammer dies made from pre-hardened die steel, it is important that the hardness is uniform throughout the block. If the die steel has too low hardenability, the block will become softer away from its outer surface and die life for deep cavities or after progressive resinking will be impaired.

### TOUGHNESS AND DUCTILITY

The surface of the cavity can during use easily develop small cracks or other blemishes which may propagate in an unstable manner under the action of the high forging stresses, especially at radii etc. Notch toughness indicates the ability of the die material to resist crack development from such defects.

All products, in the ASSAB tool steel programme for the forging industry, are characterised by the highest levels of toughness and ductility in all directions in the bar or block. Hence, the forger can rest assured

that the resistance to gross cracking is the highest possible in dies made from ASSAB die steel.

Proper die preheating will considerably reduce the risk for catastrophic failure via cracking.

### TEMPER RESISTANCE

The better the steel retains its hardness as the temperature or the time increases, the better its temper resistance.

Temper resistance can be assessed from the tempering curve for a hardened tool steel. In this, the hardness at room temperature is plotted against tempering temperature for given tempering time. Another method of presenting temper resistance data is to plot room temperature hardness against time at a given tempering temperature.



### HOT STRENGTH AND HOT HARDNESS

In contrast to temper resistance, which is defined in terms of hardness at room temperature, hot strength and hot hardness refer to properties at high temperature. In general, improved temper resistance is associated with increased hot strength and hot hardness. It can be pointed out that good hot hardness and hot strength are important prerequisites for enhanced wear resistance at elevated temperatures.

A high level of hot hardness and hot strength is also important in order to achieve adequate resistance to thermal fatigue cracking.

### FATIGUE RESISTANCE

ASSAB tool steel for forging dies are produced to the highest possible quality standards, especially with regard to freedom from nonmetallic inclusions. This imparts a degree of fatigue resistance which is adequate for even the most demanding applications where forging dies are subjected to cyclic loading with high maximum loads. batch to batch.

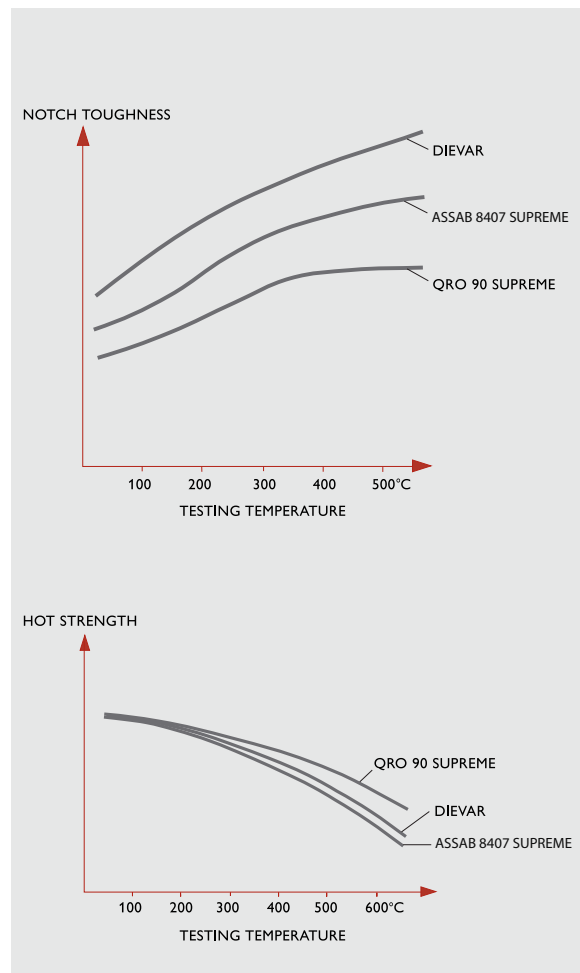

# MANUFACTURE AND MAINTENANCE OF FORGING DIE

Machinability, weldability and, when applicable, response to heat treatment and surface treatment are important parameters influencing the relative ease of manufacture and maintenance of forging dies.

## MACHINABILITY

Machinability is a vital consideration when forging dies are machined from prehardened die blocks.

The tool steel for forging applications from ASSAB are characterised by freedom from oxidic inclusions and a uniform microstructure.

These features, in combination with the low hardness in the annealed condition usually 170–200 HB, are to ensure excellent machinability.

Even if these grades are supplied prehardened, the extreme cleanliness and microstructural homogeneity ensure that machining can normally be carried out without difficulty.

For all products, advanced process control guarantees that the variations in machining characteristics are minimal from batch to batch.

## HEAT TREATMENT

If forging dies are manufactured from die steel in the annealed condition, then the tool must subsequently be heat treated in order that the steel develops its optimum combination of hardness, toughness, heat resistance and wear resistance.

These properties are controlled through proper choice of austenitizing temperature, cooling conditions during hardening and tempering temperature and time.

For forging dies, where toughness is of the utmost importance, it is essential that the cooling rate during hardening is sufficiently rapid that undesirable microconstituents such as pronounced grain-boundary carbide precipitation, pearlite and coarse upper bainite can be avoided. Furthermore, the austenitizing conditions should be such that excessive grain growth can not occur, since this is detrimental as regards to toughness. Because forging dies are sometimes EDM'd extensively after heat treatment, there is generally no problem to cope with the greater dimensional change and distortion which results when the rate of cooling during hardening is rapid. Remember, however, that EDM'd dies should always be given an additional temper at about 25°C below the previous tempering temperature. Detailed heat treatment recommendations for the various grades, in ASSAB's tool steel programme for forging dies, are given in the product brochure.

## WELD REPAIR OF FORGING DIES

Cracked or worn forging dies are often refurbished via welding. This is especially true in the case of large dies where the tool steel itself represents a considerable portion of the total die cost.

## SURFACE TREATMENT

The cavity in forging dies is quite often surface treated in order to enhance wear resistance.

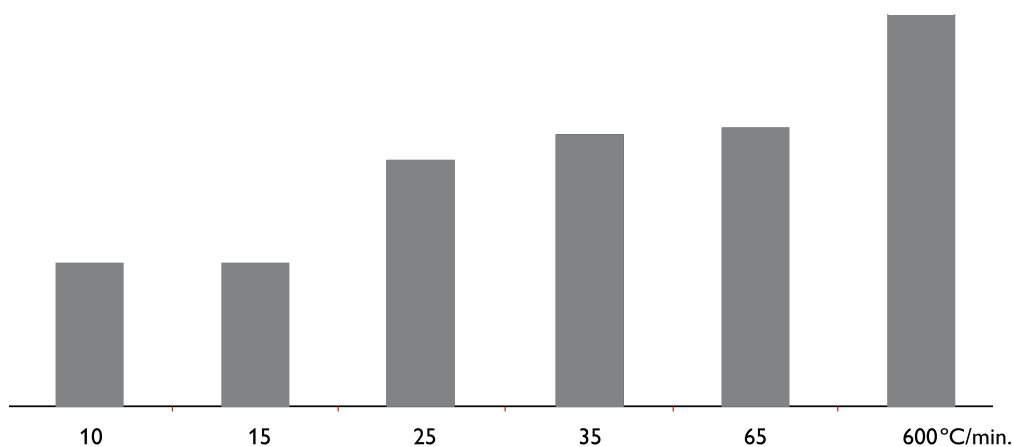

Notch toughness of ASSAB 8407 Supreme, 44–46 HRC, as a function of quench rate.

## NITRIDING

Nitriding is a thermochemical treatment giving a hard surface layer which is very resistant to wear. In favourable cases, the process also renders a compressive residual stress in the surface of the die which helps counteract heat checking.

However, the nitrided layer is very brittle and may crack or spall when subjected to mechanical loading, especially impact loading. Nitriding is usually carried out by one of four methods, nitrocarburizing in salt-bath or gas, gas nitriding or plasma (ion) nitriding.

Before nitriding, the tool should be hardened and double tempered, the latter at a temperature at least 25–50°C (50–90°F) above the nitriding temperature. The surface hardness attained and the thickness of the nitrided layer depend on the nitriding method, nitriding time and the character of the steel being treated. Typical data can be found in the ASSAB product brochures for the different tool steel.

Nitriding to layer thicknesses >0.3 mm is not to be recommended for forging dies. The reason is that the nitrided layer is brittle and easily cracks during service. The underlying steel can not resist the propagation of such surface cracks if the layer thickness is too great and the entire die may fail catastrophically.

0.3 mm maximum nitride layer thickness is a general recommendation; this maximum value should be decreased if the impression has very sharp radii or if the die steel is used at high hardness.

The formation of the so-called “white layer” should also be avoided because of brittleness.

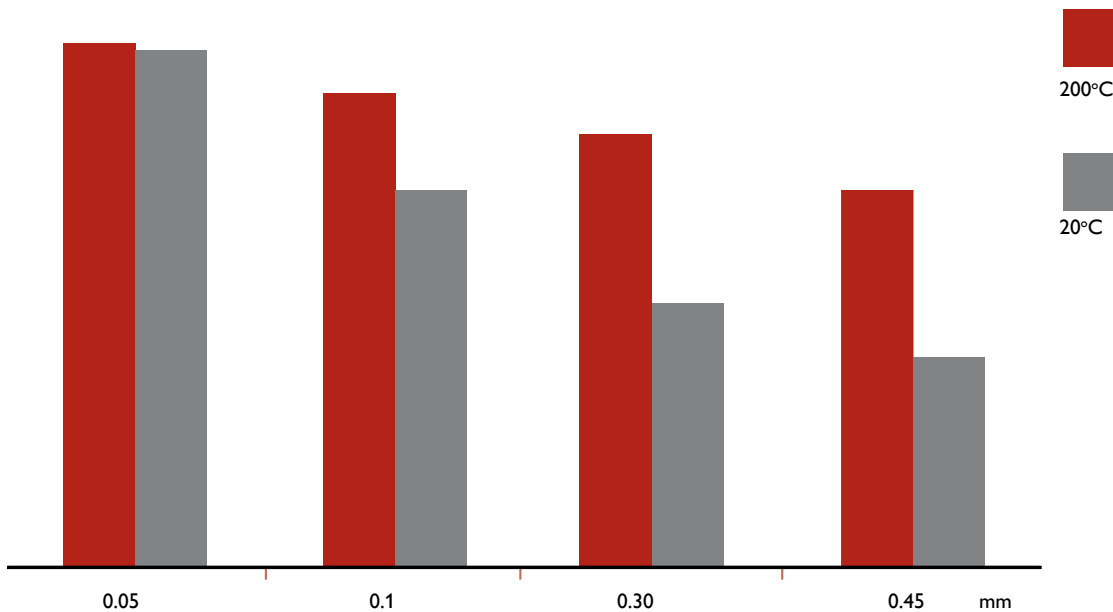

Bending strength of ASSAB 8407 Supreme as a function of nitriding depth.

# PRODUCT PROGRAMME FOR FORGING APPLICATIONS

























## GENERAL DESCRIPTION

ASSAB grade	Characteristic / Application
DIEVAR	Dievar possesses a combination of excellent toughness and very good hot strength, resulting in a superior hot-work die steel that have excellent resistance to heat checking and gross cracking. It is specifically developed to improve the potential heat-checking resistance above and beyond that of other commercially available die steels. Dievar is capable of achieving its very unique properties profile in even the largest of cross sections. Such unique properties profile makes it a suitable choice for high demand hot-work applications like die casting, forging and extrusion.
UNIMAX	Unimax is a universal tool steel with an excellent combination of high ductility and high hardness. Due to its exceptional properties, it can be used for cold-work, plastic-moulding and hot-work applications. Typical forging applications include — warm forging and progressive forging. Unimax is also a perfect choice for making trimming tools (i.e., punch and die). It is ideal for both hot trimming and cold trimming applications.
ASSAB 8407 2M	ASSAB 8407 2M is a H13 grade with good high-temperature strength and hot-wear resistance. It has a comprehensive dimension programme of round sizes. 8407 2M is processed in a special way (microdisised) giving a high purity and a good structure for better tool performance.
ASSAB 8407 SUPREME	ASSAB 8407 Supreme is an electroslag remelted steel, which attains high purity and a very fine structure. It is a premium H13 grade with significantly improved isotropic properties compared to conventionally produced H13 grades. This improvement, coupled with a high level of cleanliness and homogeneous structure, makes 8407 Supreme particularly suitable for demanding applications (e.g., tooling subjected to high stresses). It meets the requirements of NADCA #207–2008..
QRO 90 SUPREME	QRO 90 Supreme has a good combination of high-temperature strength, temper resistance and thermal conductivity. QRO 90 Supreme has given many outstanding results for press forging of steel and brass, particularly in small- and medium-sized inserts or dies. It is also eminently suitable for progressive forging, upset forging, extrusion forging, powder forging and all processes where heavy water cooling is used.
Formvar	Formvar is a solid upgrade choice from H11/H13 forging dies. With good tempering resistance and hot yield strength.
ASSAB PM 23 SUPERCLEAN ASSAB PM 30 SUPERCLEAN	Powder metallurgy high-speed steels characterised by high compressive strength, high hardness after hardening, good toughness, very good wear resistance, very good dimensional stability during heat treatment, and very good tempering resistance. These grades are used for forging applications where very good wear resistance is needed.

## CHEMICAL COMPOSITION

ASSAB grade	AISI (WNR)	Analysis %							Supplied hardness Brinell
		C	Si	Mn	Cr	Mo	V	Others	
DIEVAR	-	0.35	0.2	0.5	5.0	2.3	0.6	-	~160
UNIMAX	-	0.50	0.2	0.5	5.0	2.3	0.5	-	~185
ASSAB 8407 2M	H13 (1.2344)	0.39	1.0	0.4	5.3	1.3	0.9	-	~180
ASSAB 8407 SUPREME	H13 (1.2344)	0.39	1.0	0.4	5.2	1.4	0.9	-	~180
QRO 90 SUPREME	-	0.38	0.3	0.8	2.6	2.3	0.9	Microalloyed	~180
FORMVAR	-	0.55	0.2	0.5	5.0	2.3	0.6	-	<229

## QUALITATIVE COMPARISON OF RESISTANCE OF BASIC PROPERTIES

ASSAB grade	Hot Wear	Plastic Deformation	Premature Cracking	Heat Checking
DIEVAR				
UNIMAX				
ASSAB 8407 2M				
ASSAB 8407 SUPREME				
QRO 90 SUPREME				
FORMVAR				

The longer the bar, the better.

## TOOL STEEL SELECTION CHART

### GENERAL RECOMMENDATIONS

Forging Application		ASSAB Steel	Hardness
Hammer forging	Inserts	DIEVAR	44 - 52 HRC
		ASSAB 8407 SUPREME	40 - 50 HRC
		ASSAB 8407 2M	40 - 48 HRC
Press forging	Dies	DIEVAR	44 - 52 HRC
		QRO 90 SUPREME	44 - 48 HRC
		UNIMAX	52 - 57 HRC
		ASSAB 840 SUPREME	40 - 50 HRC
		ASSAB 8407 2M	38 - 48 HRC
Warm forging	Tools	UNIMAX	53 - 58 HRC
		DIEVAR	50 - 52 HRC
Progressive forging	Tools	QRO 90 SUPREME	42 - 52 HRC
		UNIMAX	52 - 58 HRC
		DIEVAR	45 - 52 HRC
Hot pressing / stamping	Dies / inserts for Cu- and Al- forgings	QRO 90 SUPREME	46 - 50 HRC
		UNIMAX	52 - 56 HRC
		DIEVAR	46 - 52 HRC
		ASSAB 8407 SUPREME	44 - 52 HRC
		ASSAB 8407 2M	44 - 50 HRC
Upset forging	Tools	UNIMAX	52 - 56 HRC
		DIEVAR	49 - 52 HRC
Trimming	Hot trimming	UNIMAX	52 - 58 HRC
		ASSAB 8407 2M	45 - 52 HRC
	Cold trimming	UNIMAX	54 - 58 HRC
CALMAX		52 - 58 HRC	
ASSAB 88		56 - 62 HRC	

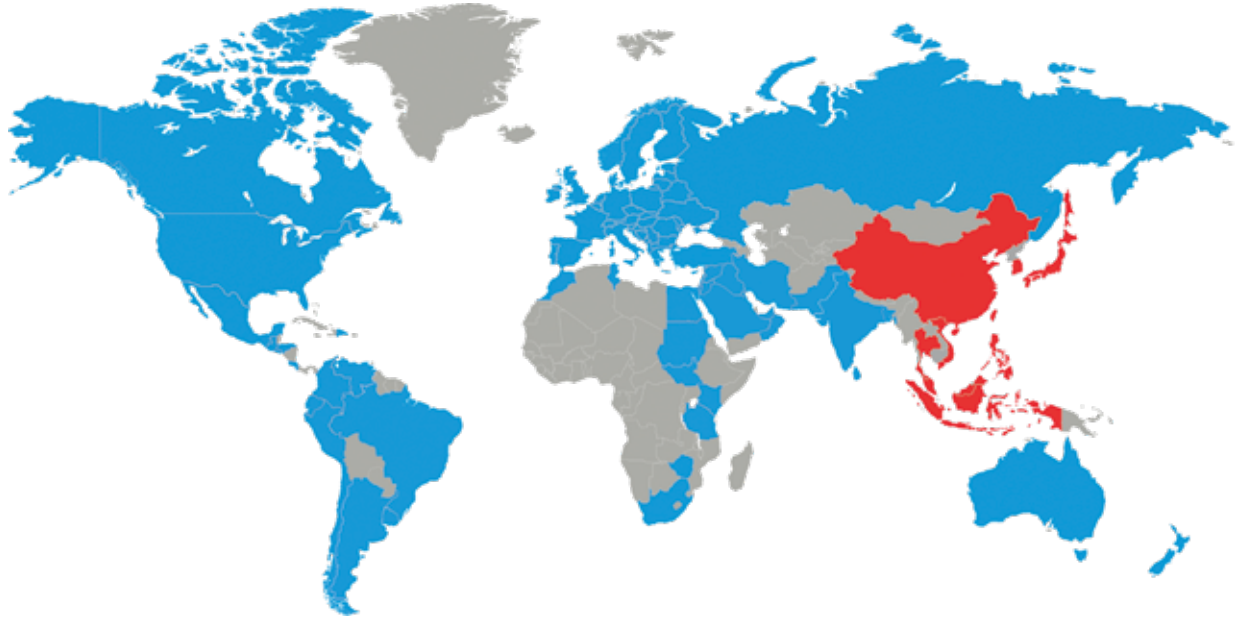

Choosing the right steel is of vital importance. ASSAB engineers and metallurgists are always ready to assist you in your choice of the optimum steel grade and the best treatment for each application. ASSAB not only supplies steel products with superior quality, we offer state-of-the-art machining, heat treatment and surface treatment services to enhance steel properties to meet your requirement in the shortest lead time. Using a holistic approach as a one-stop solution provider, we are more than just another tool steel supplier.

ASSAB and Uddeholm are present on every continent. This ensures you that high quality tool steel and local support are available wherever you are. Together we secure our position as the world's leading supplier of tooling materials.

For more information, please visit  
[www.assab.com](http://www.assab.com)

